

Linear 50

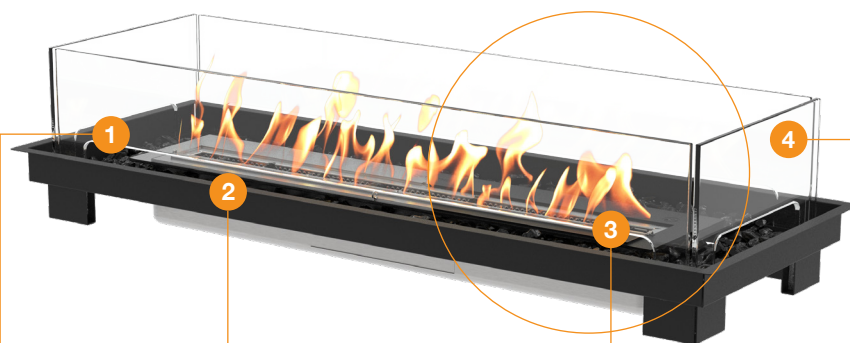

Linear 50 Design features



1. Decorative Media

Fire Pit Kits come with black glass charcoal.

Quick & Easy Installation

EcoSmart Fire Pit Kits are completely self-contained, which makes them much simpler to install than gas or wood burning fireplaces. No flashing, roof work or plumbing is required for installation.

Simply drop into and then dress around the fireplace with your chosen finishing touch.

2. Black Hi-Temp Coated Stainless Steel Tray

All Fire Pit Kits feature an Inlay Black Tray to house the compatible burner, included decorative media and glass fire screen.

No Flue or Chimney Needed

Our fireplaces don't need a chimney to vent harmful gases as burning liquid bioethanol doesn't produce any smoke.

No Gas or Electricity

All the fuel is housed within the self-contained burner so you don't have to run pipes or cables through your walls.

3. Colours

Available with a Stainless Steel or Black Burner with a Black Inset Metal Tray.

Versatile and Incredibly Durable

EcoSmart Fire Pits are versatile, incredibly durable, and are constructed of weather resistant materials. These appliances are designed to look great for years, and will perform admirably through all four seasons.

4. Fire Screen

The toughened glass fire screen stabilises the flame in windy conditions.

Environmentally-Friendly

Bioethanol fireplaces use an environmentally-friendly, renewable energy source that burns clean and delivers warming heat. You and your guests will enjoy the ambiance and tranquility of a real fire, without the hassles of burning real wood - no more embers, ash, and soot to clean up.

Global Compliance

This model complies with existing standards in the USA, Europe, UK and Australia. O-TL listed to UL1370, EN 16647 BSI Certified and ACCC Safety Mandate compliant.

Linear 50 Accessories



Included Accessories



Decorative Glass Charcoal

Our Glass Charcoal is made from high-quality tempered glass.



Glass Fire Screen

Paired with the linear (L1080) glass fire screen, to stabilise the flame in windy conditions.



Jerry Can with Safety Spout and e-NRG bottle adaptor

Jerry Can allows safe storing/decanting of e-NRG ethanol. e-NRG adaptor connects the Safety Spout to an e-NRG bottle.



Lighting Rod & Lighter

The Lighting Rod is designed to safely adjust the slider position on the burner. It is also used for the ignition procedure.



XL Baffles

Placed over the internal burner vents, they serve to increase the efficiency of the burner as well as further stabilise the flame.

Optional Accessories



Outdoor Burner Cover

Black silicone outdoor burner covers protect burners from the elements when not in use.

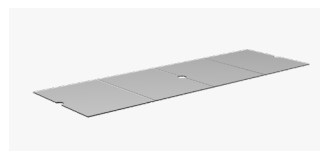

Glass Cover Plate



Enables fire pit tables to easily be transformed into a usable coffee table surface.

Linear 50 Specifications

Modern and versatile, Linear 50 Fire Pit Kit provides an elegant, elongated flame from a single XL900 Burner. Ideal for homes and intimate commercial settings.

Ventilation and Efficiency*

| Model Dimensions L x W x H mm/in | Compatible Burner | Fuel Capacity | Heats on Average (Indoors) | Thermal Output Net (MAX per burner) | Approx. Burn Time | Minimum Room Size |
|--------------------------------------|-------------------|-------------------|--|-------------------------------------|-------------------|--|
| 1195 x 430 x 310 47.1 x 17 x 12.1 | XL900 | 9 L [2.4 Gals] | Over 60 m ² [645 ft ²] | 16 MJ/h 15,000 BTU/h, 4.4 kW | 8 - 13 hours | 110 m ³ [3,884 ft ³] |

| | |
|----------------|---|
| Application | Indoor ¹ & Outdoor |
| Colour |  Black ESF.B.FPK.L.50 |
| Burner Colours |  Stainless Steel  Black |
| Materials | Black Hi-Temp Coated Stainless Steel Tray, Toughened Glass Fire Screen, Grade 304 Stainless Steel Burner, with optional Black Ceramic Coating |
| Approx. Weight | 41.3kg [90.9lbs] Weight includes burner and accessories. |
| Fuel Type | e-NRG Bioethanol / e-NRG.com |

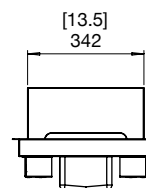
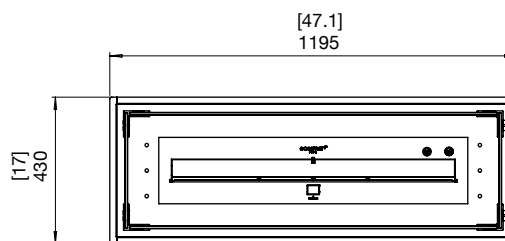
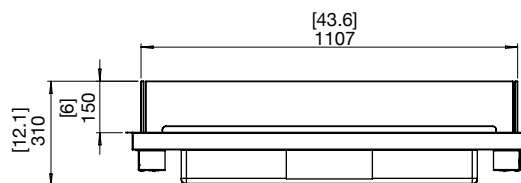

*These values are indicative only and may vary depending on the model purchased, installation, and the seasonal resource used to manufacture e-NRG.

¹For Indoor Use, additional parts are required. Your chosen application is the ONLY application the model can be used in due to modified configuration of the model. Please advise your Sales Representative at time of purchase so that the product can be configured accordingly. Read the manual carefully before operating the burner. Physical model dimensions should be verified against cut out dimensions BEFORE installation begins to confirm tolerances align. This model complies with existing standards in the USA, Europe, UK and Australia. O-TL listed to UL1370, EN 16647 BSI Certified and ACCC Safety Mandate compliant. To comply with EN 16647 the Indoor Safety Tray must be installed before operating indoors.

FOR MORE INFORMATION PLEASE REFERENCE THE CLEARANCE & INSTALLATION MANUAL

Disclaimer. All product specifications and data are subject to change without notice and believed to be correct at the time of publication. MAD Design Group (MDG), its affiliates, agents, and employees, and all persons acting on its or their behalf (collectively, "MAD Design Group"), disclaim any and all liability for any errors, inaccuracies or incompleteness contained herein or in any other disclosure relating to any product. MDG disclaims any and all liability arising out of the use or application of any product described herein or of any information provided herein to the maximum extent permitted by law. The product specifications do not expand or otherwise modify MDG's terms and conditions of purchase, including but not limited to the warranty expressed therein, which apply to these products. No license, express or implied, by estoppel or otherwise, to any intellectual property rights is granted by this document or by any conduct of MDG. Customers using or selling MDG products not expressly indicated for use in such applications do so entirely at their own risk and agree to fully indemnify MDG for any damages arising or resulting from such use or sale. Please contact authorised personnel from MDG to obtain written terms and conditions regarding products designed for such applications. Images are indicative only.

Linear 50 Cut-out dimensions

Physical model dimensions should be verified against cut out dimensions BEFORE installation begins to confirm tolerances align.

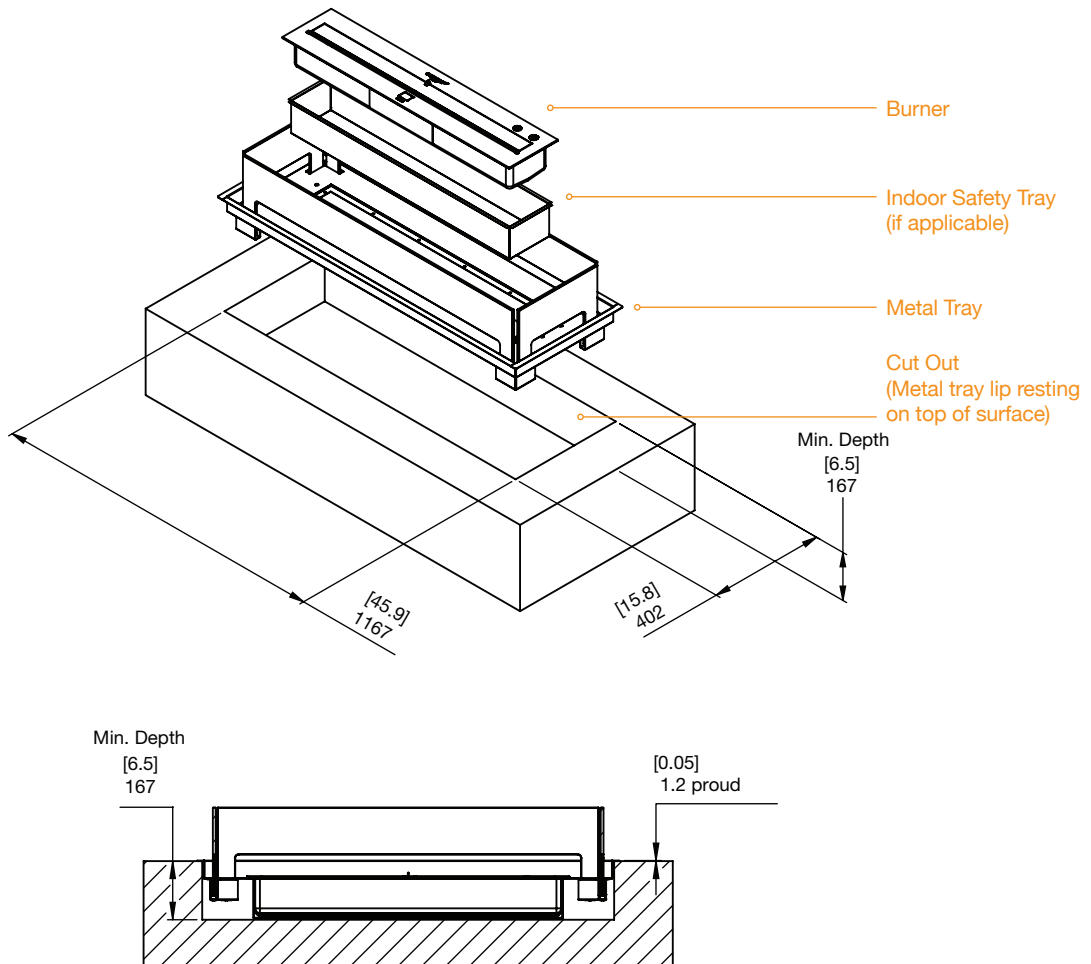

FOR MORE INFORMATION PLEASE REFERENCE THE CLEARANCE & INSTALLATION MANUAL

Disclaimer. All product specifications and data are subject to change without notice and believed to be correct at the time of publication. MAD Design Group (MDG), its affiliates, agents, and employees, and all persons acting on its or their behalf (collectively, "MAD Design Group"), disclaim any and all liability for any errors, inaccuracies or incompleteness contained herein or in any other disclosure relating to any product. MDG disclaims any and all liability arising out of the use or application of any product described herein or of any information provided herein to the maximum extent permitted by law. The product specifications do not expand or otherwise modify MDG's terms and conditions of purchase, including but not limited to the warranty expressed therein, which apply to these products. No license, express or implied, by estoppel or otherwise, to any intellectual property rights is granted by this document or by any conduct of MDG. Customers using or selling MDG products not expressly indicated for use in such applications do so entirely at their own risk and agree to fully indemnify MDG for any damages arising or resulting from such use or sale. Please contact authorized personnel from MDG to obtain written terms and conditions regarding products designed for such applications. Images are indicative only.